



# 成功大學校園綠建築規範

From：綠建築組

# 簡報內容

1

成功大學綠建築規範目錄

2

成功大學綠建築規範內容

# 成功大學綠建築規範目錄

## 一、前言

## 二、成功大學校園綠建築環境現況分析

- 校園水循環現況調查解析
- 校園建築節能現況解析
- 校園建築節水現況解析
- 校園建築污水現況調查解析
- 校園垃圾及廢棄物處理現況調查解析

## 三、成功大學綠建築規劃設計準則

- 建築外殼節能
- 空調節能
- 照明規範
- 節水器材
- 地面透水
- 綠色建材

綠建築解說與評估手冊

綠建材解說與評估手冊

# 要求拿到銀級綠建築標章

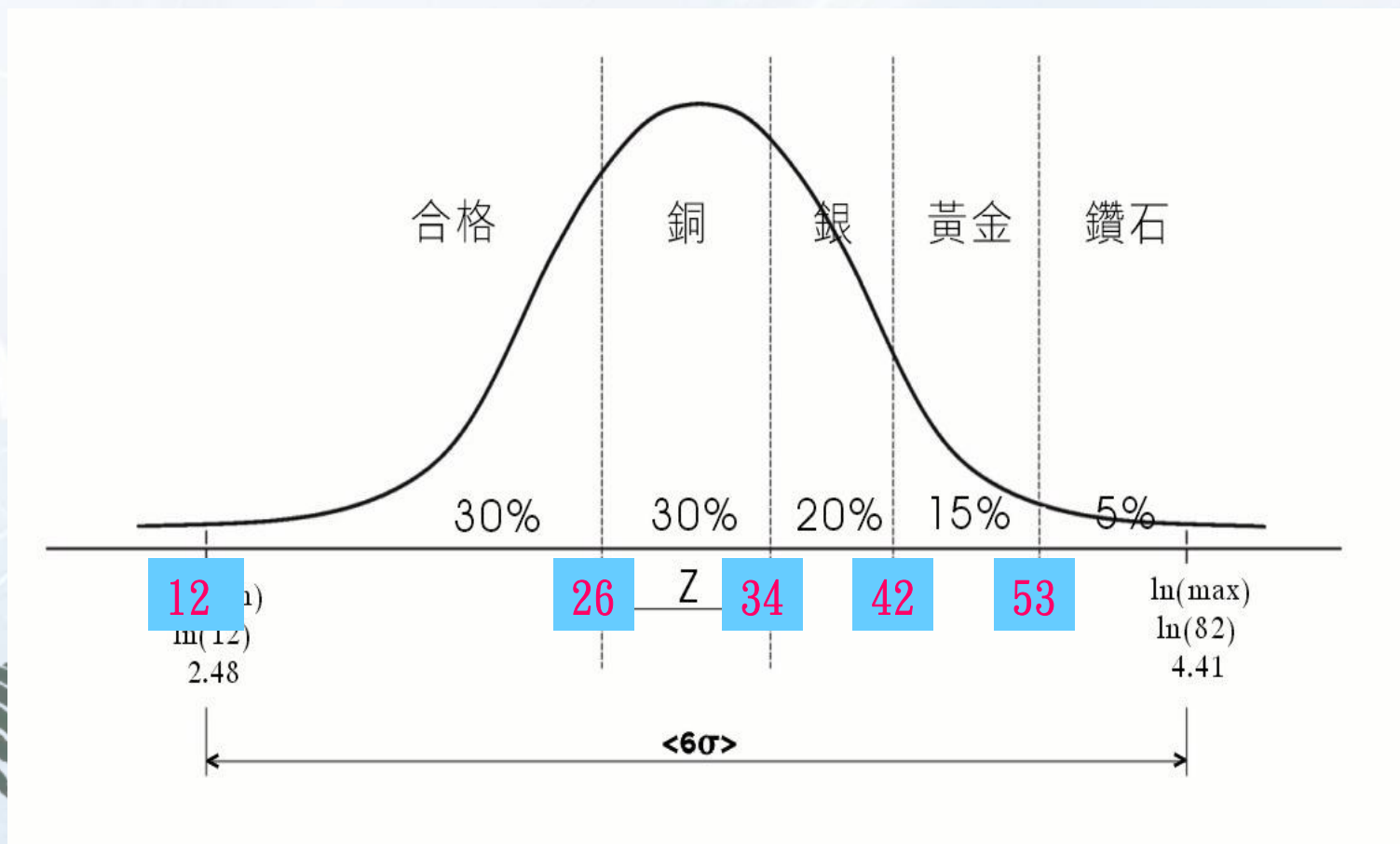

# 成功大學綠建築規範內容

- ❖ 建築外殼節能 (亞熱帶的建築風格)
- ❖ 空調節能
- ❖ 照明規範
- ❖ 節水器材
- ❖ 地面透水
- ❖ 綠色建材

## 亞熱帶的建築風格

- 建立充滿陰影開口的校園建築，建築物開口部平均遮陽保護角在0.7以上
  - $X / Y \geq 0.7$

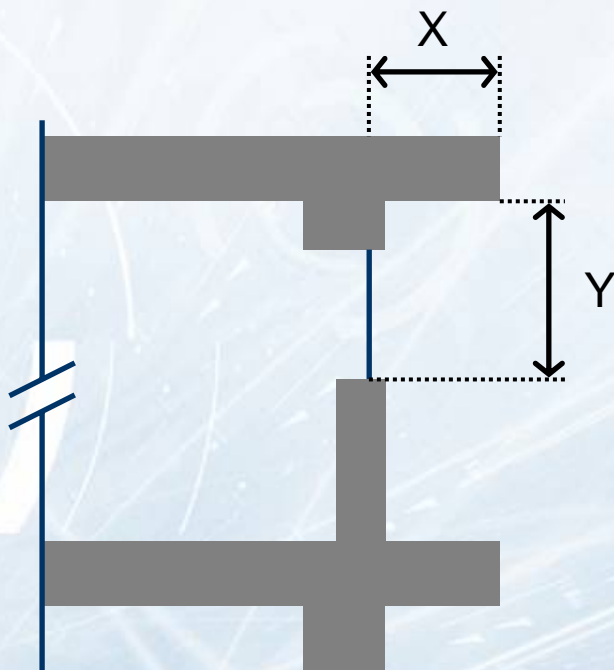

## 亞熱帶的建築風格

- 對於校園建築物水平透光開窗設置，水平透光天窗日射透過率應控制在15%以下

台南大學  
圖書行政大樓



苗栗醫院



開口率40%之頂層空間，大約會增加70-80%的空調耗電量

# 亞熱帶的建築風格

- 提升屋頂構造及隔熱能力，利用隔熱層以達隔熱目的，平均屋頂熱傳透率 $U_i$ 值應在0.8以下

屋頂空氣層

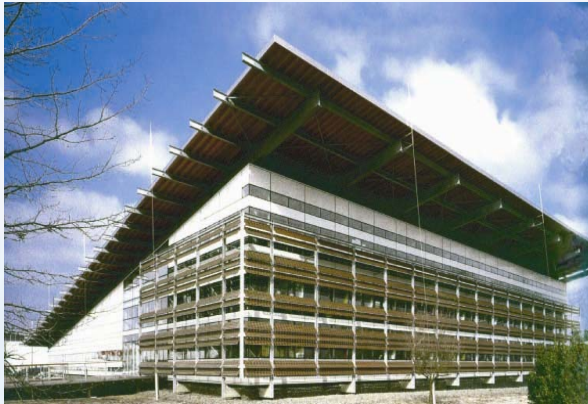

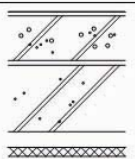
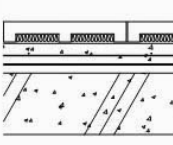
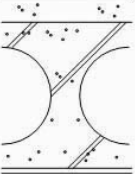
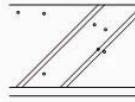
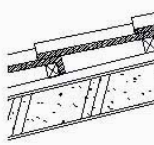
構造	編號	構造大樣	厚度 dx [m]	熱阻係數 $1/kx$ [m·K/W]	熱傳透率 $U_i = 1/R$ [W/ m <sup>2</sup> k]
泡沫混凝土	R007		外氣膜 ---- PU板 0.0020 泡沫混凝土 0.1000 油毛氈 0.0100 鋼筋混凝土 0.1500 空氣層 ---- 岩棉吸音板 0.0150 內氣膜 ----	1/23.000 1/0.050 1/0.170 1/0.110 1/1.400 0.086 1/0.064 1/7.000	0.75
五腳磚油毛氈	R008		外氣膜 ---- 水泥五腳磚(附保力龍) 0.0500 保力龍 0.0200 輕質混凝土 0.0500 PU或油毛氈 0.0100 水泥砂漿 0.0200 鋼筋混凝土 0.1500 水泥砂漿 0.0150 內氣膜 ----	1/23.000 1/1.500 1/0.040 1/0.800 1/0.110 1/1.500 1/1.400 1/1.500 1/7.000	0.99
中空樓板	R009		外氣膜 ---- PU 0.002 泡沫混凝土 0.080 水泥砂漿 0.0150 鋼筋混凝土 0.075 鋼管 0.001 空氣層 ---- 鋼管 0.001 鋼筋混凝土 0.075 水泥砂漿 0.010 內氣膜 ----	1/23.0 1/0.05 1/0.17 1/1.50 1/1.40 1/45.0 0.086 1/45.0 1/1.40 1/1.50 1/7.00	1.10
PU膜	R010		外氣膜 ---- PU 0.0020 水泥砂漿 0.0150 鋼筋混凝土 0.1500 水泥砂漿 0.0150 內氣膜 ----	1/23.000 1/0.050 1/1.500 1/1.400 1/1.500 1/7.000	2.83
陶瓦	R011		外氣膜 ---- 陶瓦 0.0500 水平掛瓦條 ---- 垂直壓條 ---- 油毛氈防水 0.0100 鋼筋混凝土 0.1500 水泥砂漿 0.0150 內氣膜 ----	1/23.000 1/1.000 0.4600 ---- 1/0.11 1/1.400 1/1.500 1/7.000	1.11





## 空調節能

- 窗型冷氣機或分離式冷氣機
  - 安裝窗型或分離式冷氣機必須採用能源等級1或2級
- 中央空調
  - 中央空調之節能設計必須依照綠建築評估手冊中提出空調負荷計算書，並依綠建築標章審查基準，不得超量設計
  - 冷凍空調主機之效率必須符合能源局標準



# 要真正的安全，不要差勁的照明

Let's have real security, not just bad lighting....



Photos by Bobby Thompson

# 光害防制的成果

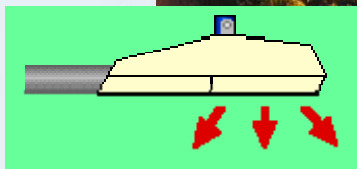
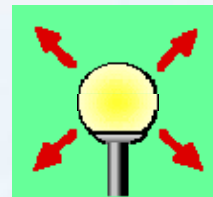
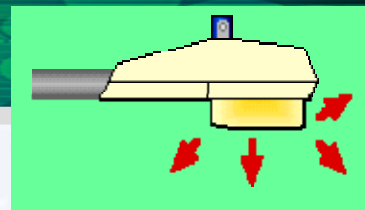

# 公共場所照明改善



婦幼安全與節約能源



# 汰換燈具與新設燈具

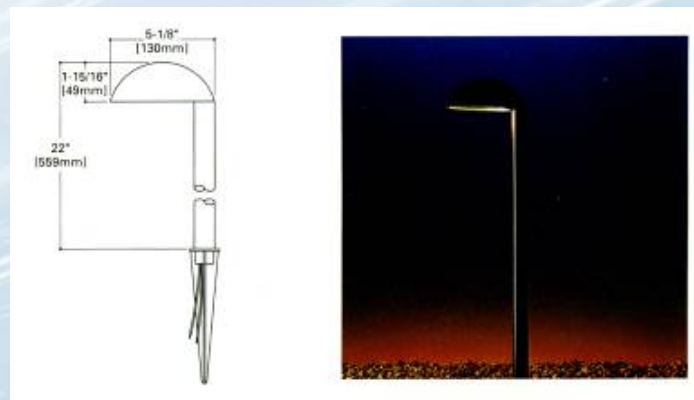
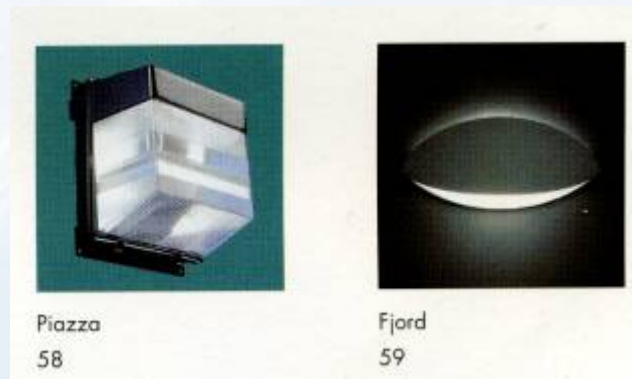
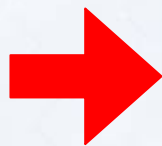

# 汰換燈具與新設燈具



## Options



Column mounted (large only)



End mounted (large)



# 照明規範

## ■ 戶外照明

### • 光源

- 室外照明的光源，從節能的觀點，應採用高效率燈具，附燈具之光源效率必須大於70 lm/W以上
- 戶外照明燈具應具有高效率反射

### • 光害防制

- 限制戶外照明燈具上方光束比（ULR）應低於15%
  - » 國際照明學會CIE戶外照明光害之限制基準
- 步行眩光防制，在鉛垂角 $90^\circ$ 以上光強要小於 $10\text{cd}/1000\text{lm}$ ，在鉛垂角 $80^\circ$ 的光強要小於 $30\text{cd}/1000\text{lm}$ 
  - » CNS 9118 道路照明燈具









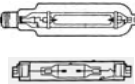

### • 節能控制

- 燈具照明分階段性控制，深夜（12:00）以後，必須能達到減半以上之電力

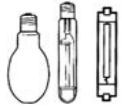
### • 降低對生物干擾



## 戶外照明高效率燈具

	光源種類	發光效率 (lm/W)	壽命 (hrs)	光源圖示	燈具型式
高強度放電燈系 (HID)	水銀燈泡	32-55	9,000~ 12,000		
	複金屬燈泡	70-90	6,000~ 9,000		
	高壓鈉氣燈泡	90-120	9,000~ 12,000		
	低壓鈉氣燈泡	140	9,000		
	氙氣燈泡	90	10,000		



# LED燈

用於室內避難逃生用指標燈  
低庭園燈  
交通信號燈



# 停止城市光廊建設



# 天空輝光的防治



# 節水器材

- 用水器具全面使用省水標章之器材及兩段式馬桶



## 地面透水

- 校園內除重車輛經過之地區鋪設柏油外，其他基地地表以透水性鋪面及地被為主



# 綠色建材

- 室內油漆
  - 校園建築室內油漆塗料，必須具有綠建材標章或環保標章認證
- 室內裝潢
  - 室內裝潢不應過度裝飾，表面建材使用面積必須達20%以上
- 室外鋪面
  - 室外鋪面必須使用50%以上之再生建材

